

Movement by Perfection

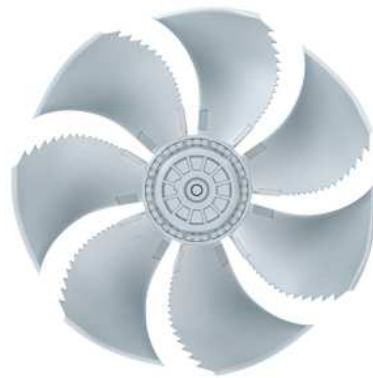

The Royal League in **ventilation**, control and drive technology



Product documentation

Type
FN050-4EK.4I.V7P1

Article number
140057

Product documentation

Customer

ZIEHL-ABEGG Contact

Project

ZIEHL-ABEGG Subsidiary
Brazil
ZIEHL-ABEGG do Brazil Imp.,
Exp. e Com. de Equipamentos
de Ventilação Ltda.
Rua Osasco, 1.295
Centro Empresarial Anhanguera
Cajamar -SP - CEP 07753-040
BRAZIL
Phone + 55 11 2898-0827
www.ziehl-abegg.com.br
info@ziehl-abegg.com.br

Type
FN050-4EK.4I.V7P1

Article number
140057

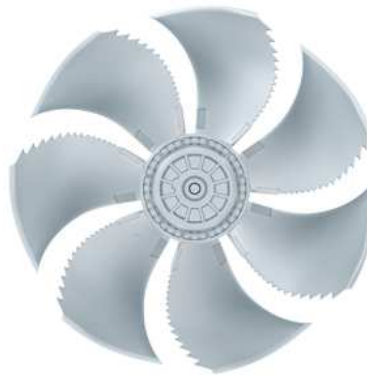

Contents

1.	Rubriküberschrift1 (CB_AF_Headline1)	Erro! Indicador não definido.
----	--------------------------------------	--------------------------------------

1. Product specification

Technical data

Article number	140057
Type	FN050-4EK.4I.V7P1
Designation	Axial fan with sickle blades
Rated values	1~230V±10% 50Hz P ₁ 0,76kW 3.30A ΔI=5% 1230/min 16.0uF/400V 70°C 1~230V±10% 60Hz P ₁ 1,05kW 4,60A ΔI=0% 1250/min 16,0uF/400V 50°C
Electrical connection	Terminal box K62
Min. operating temperature °C	-25
Mounting type terminal box	Mounted on Stator
Type of protection	IP54
Thermal class	THCL155
Connection diagram	1360-104XA
Rating plate	1x fixed
Fitting position	H/Vu/Vo
Motor protection	thermal contact
Impregnation	Moisture and hot climate protection
Quality of bearings	ball bearing with long-time lubrication
Material Rotor	Aluminium
Painting rotor	unpainted
Material blades	Aluminium
Painting impeller	unpainted
Guard grille type	ring grill
Other	Balancing quality G 4,0
Painting mot.suspens	Motor suspension powder-coated consistency class 2
colour suspension	RAL 9005 (jet black)
Weight kg	13,30
ErP Data	Efficiency η_{statA} : 28,9 % Efficiency: $N_{actual} = 36,3 / N_{target} = 36^*$ *ErP 2013Does not comply with the stipulations of the ErP regulations

2. Characteristic Curve

Air performance

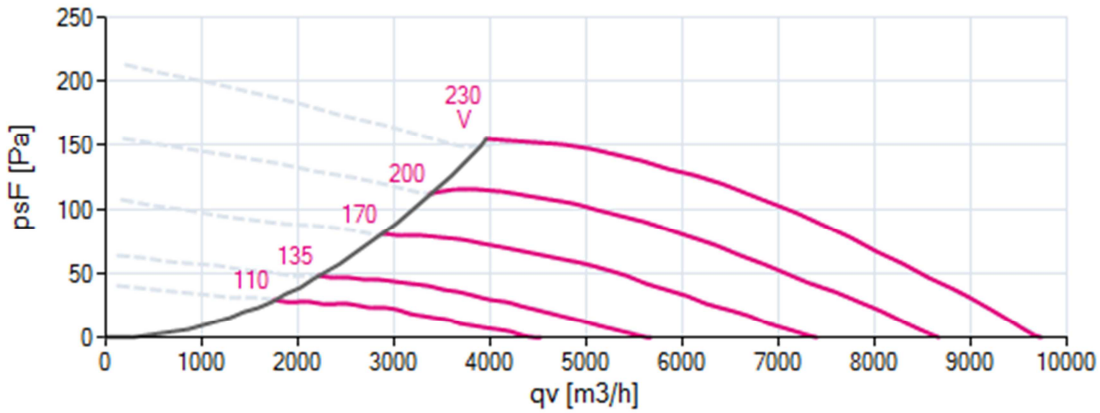

Acoustics

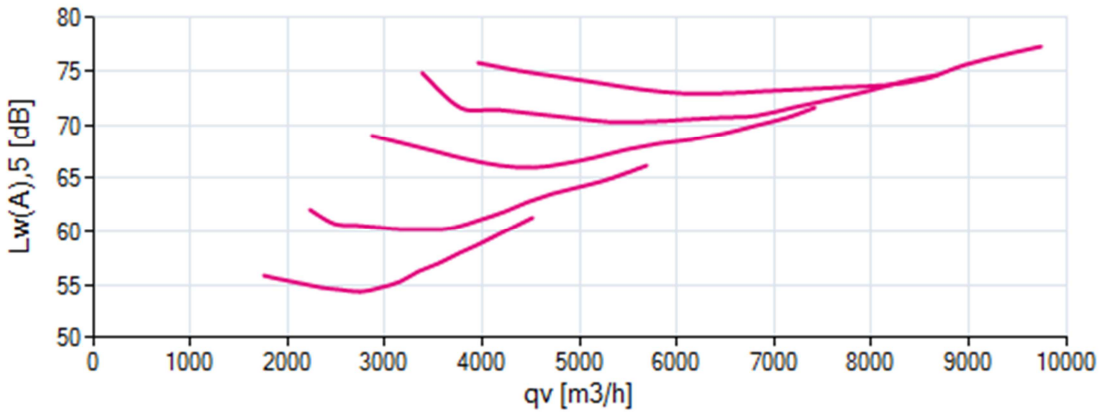

Power input

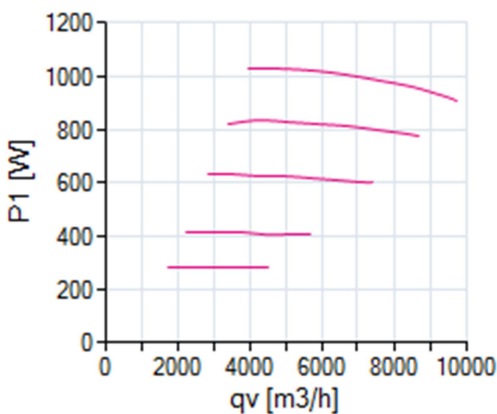

Efficiency

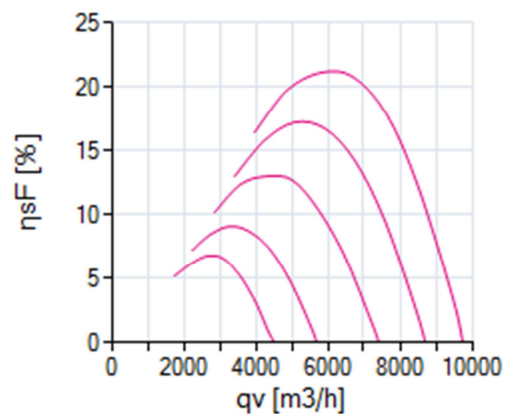

measured in full bell mouth without guard grille in installation type A according to ISO 5801

Please note: It's not allowed to use this fan in the stall area!*

*In doubt please ask your responsible ZIEHL-ABEGG sales contact.

Article number
140057

The Royal League

Die Königsklasse

Data of operating point

frequency (f_{BP})	60
mains supply	1~ 230V 60Hz
guard grille	no

3. Drawing

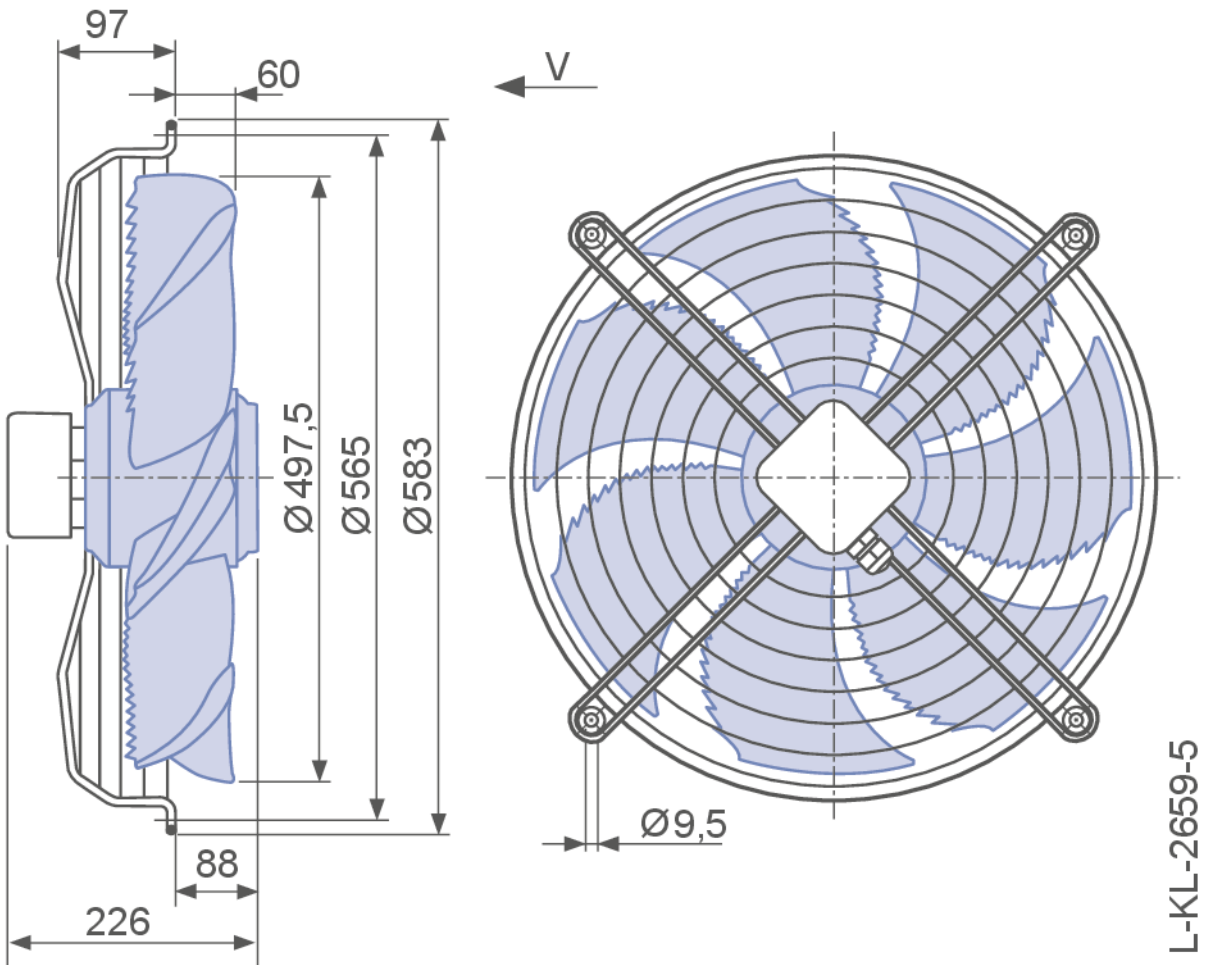

Dimensions in mm
Shown drawing is just to show the dimensions of the fan.

4. Connection diagram

1360-104XA

1~Motor with capacitor and thermostatic switch (if built in).

- U1 brown
- U2 blue
- Z1 black
- Z2 orange
- TB white

Clockwise rotation

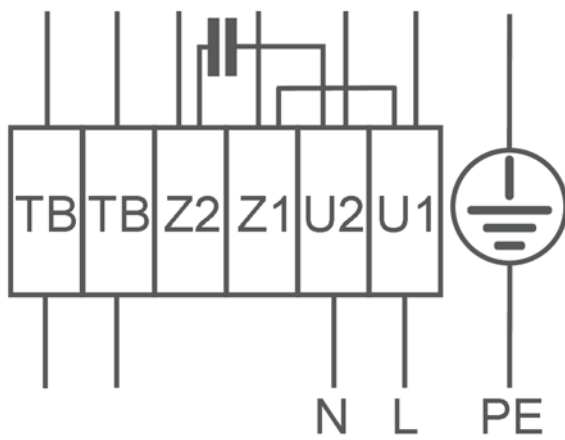

5. EU-Declaration of conformity



The Royal League in ventilation, control and drive technology

Intelligent control technology for any application

ZIEHL-ABEGG system capabilities:
Everything from a single source – perfectly matched for optimal performance

Please contact us. We would be pleased to design an individual solution for your requirements.

We would like to welcome you on our worldwide exhibitions. Please find our next exhibitions [here](#).